

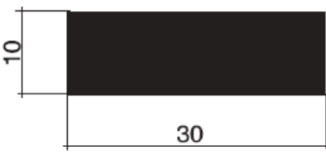
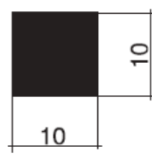

Solid Rubber profiles special sections

EPDM: Shore 70 (+/-5)

					
mm	codice	mm	codice	mm	codice
10x5	PA752-S10x5	5x5	PA752-S5x5	6	PA752-GP6
10x8	PA752-S10x8	8x8	PA752-S8x8	7	PA752-GP7
12x8	PA752-S12x8	10x10	PA752-S10x10	8	PA752-GP8
15x5	PA752-S15x5	12x12	PA752-S12x12	9	PA752-GP9
15x10	PA752-S15x10	15x15	PA752-S15x15	10	PA752-GP10
20x5	PA752-S20x5	20x20	PA752-S20x20	12	PA752-GP12
20x10	PA752-S20x10	25x25	PA752-S25x25	18	PA752-GP18
25x10	PA752-S25x10	30x30	PA752-S30x30	25	PA752-GP25
30x5	PA752-S30x5			40	PA752-GP40
30x10	PA752-S30x10			50	PA752-GP50
30x20	PA752-S30x20				
40x20	PA752-S40x20				
50x20	PA752-S50x20				
60x20	PA752-S60x20				

On request to provide any measure

Solid Rubber profiles special sections

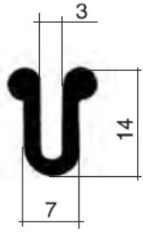

PA7100895-000
EPDM

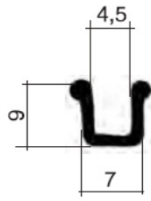

PA7100952-000
EPDM
(mm 2000)

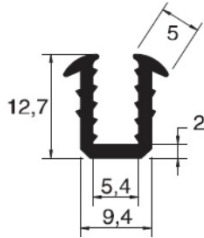

PA7100757-000
EPDM

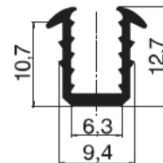

PA7101422-000
EPDM

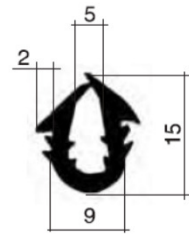

PA7100752-000
EPDM

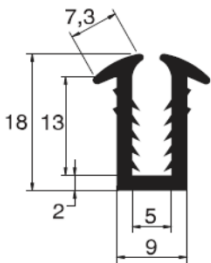

PA7100774-000
EPDM

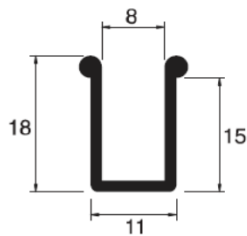

PA7100646-000
EPDM

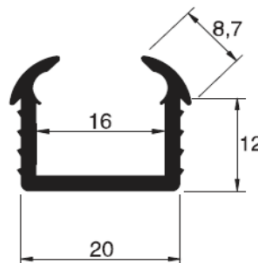

PA7100641-000
EPDM

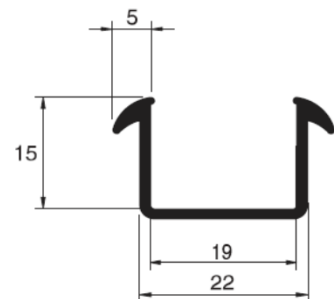

PA7100689-000
EPDM

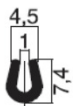

PA7200271-000
PVC
With or without adhesive
hot melt

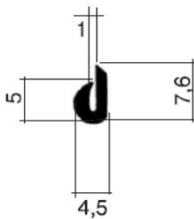

PA7200046-000
PVC

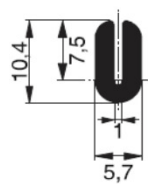

PA7200228-000
PVC

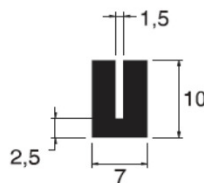

PA7100650-000
EPDM

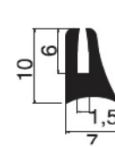

PA7200543-000
PVC

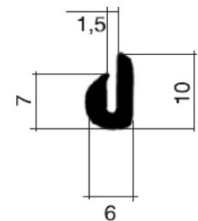

PA7200028-000
PVC

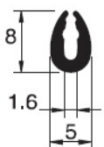

PA7200321-000
PVC
With or without adhesive
hot melt

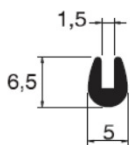

PA7200144-000
PVC



PA7100765-000
EPDM

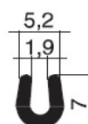

PA7200145-000
PVC
With or without adhesive
hot melt

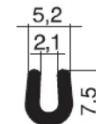

PA7200104-000
PVC
With or without adhesive
hot melt

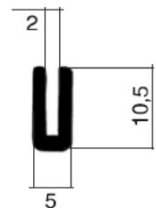

PA7200361-000
PVC

Solid Rubber profiles special sections

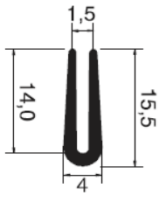

PA7100620-000
EPDM

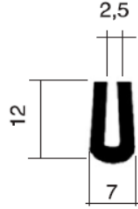

PA7200138-000
PVC

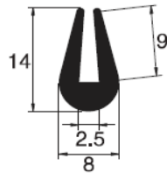

PA7100770-000
EPDM



PA7101950-000
EPDM



PA7200161-000
PVC

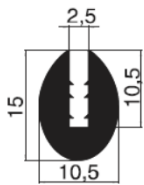

PA7200176-000
PVC

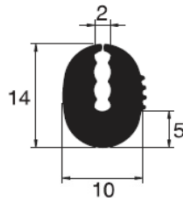

PA7100726-000
EPDM

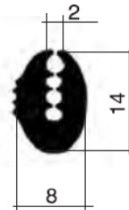

PA7100806-000
EPDM

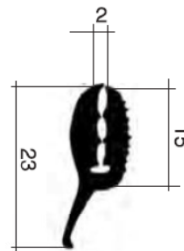

PA7100807-000
EPDM

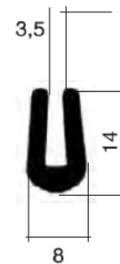

PA7200139-000
PVC

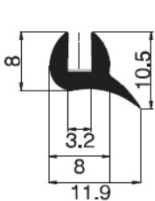

PA7200225-000
PVC
With or without adhesive
hot melt



PA7100740-000
EPDM

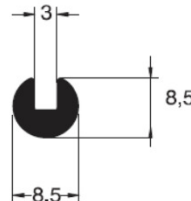

PA7200036-000
PVC
With or without adhesive
hot melt

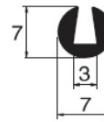

PA7100717-000
EPDM

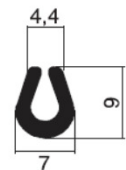

PA7200106-000
PVC
With or without adhesive
hot melt

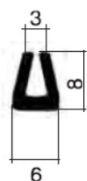

PA7100802-000
EPDM



PA7101981-000
EPDM

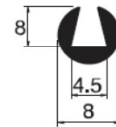

PA7100720-000
EPDM



PA7101982-000
EPDM

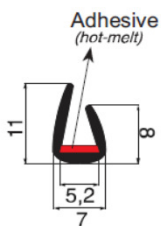

PA7200521-000
PVC
With or without adhesive
hot melt

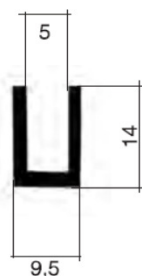

PA7200164-000
PVC

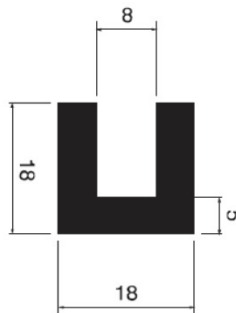

PA7102123-000
EPDM

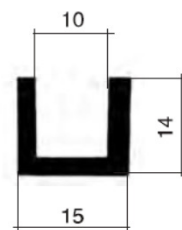

PA7100556-000
EPDM

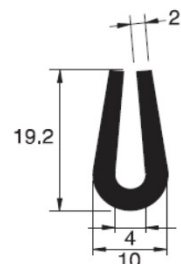

PA7100631-000
EPDM

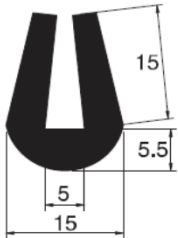

PA7100559-000
EPDM

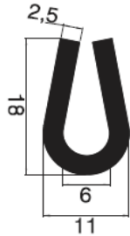

PA7101983-000
EPDM

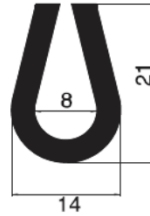

PA7101984-000
EPDM

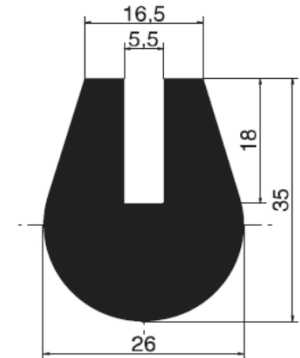

PA7101476-000
EPDM

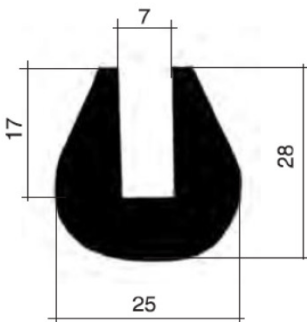

PA7100913-000
EPDM

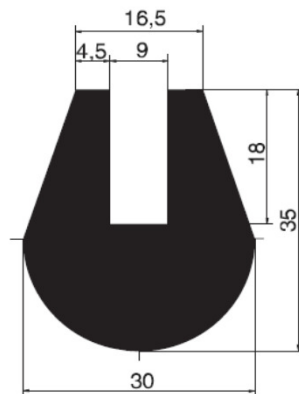

PA7101517-000
EPDM

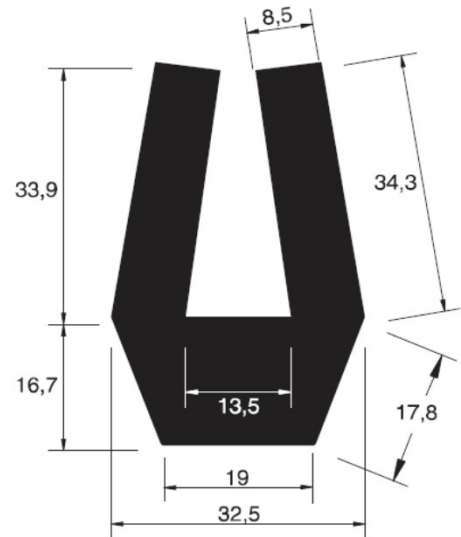

PA7100792-000
EPDM

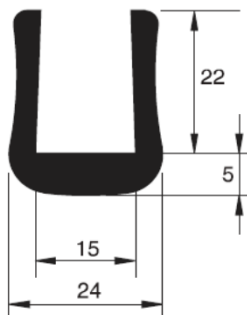

PA7100775-000
EPDM

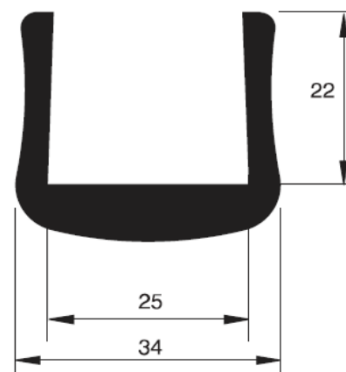

PA7100777-000
EPDM

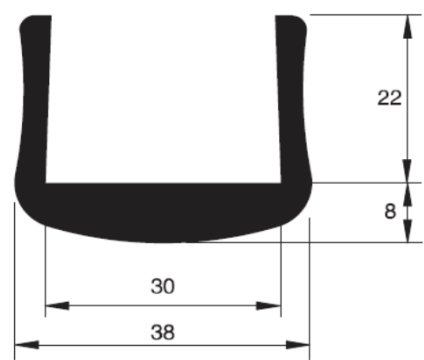

PA7100779-000
EPDM