

HINGE 180°

RH or LH application.
180° Opening angle,

Material:

Hinge : PA Black

Pin: nickel plated steel

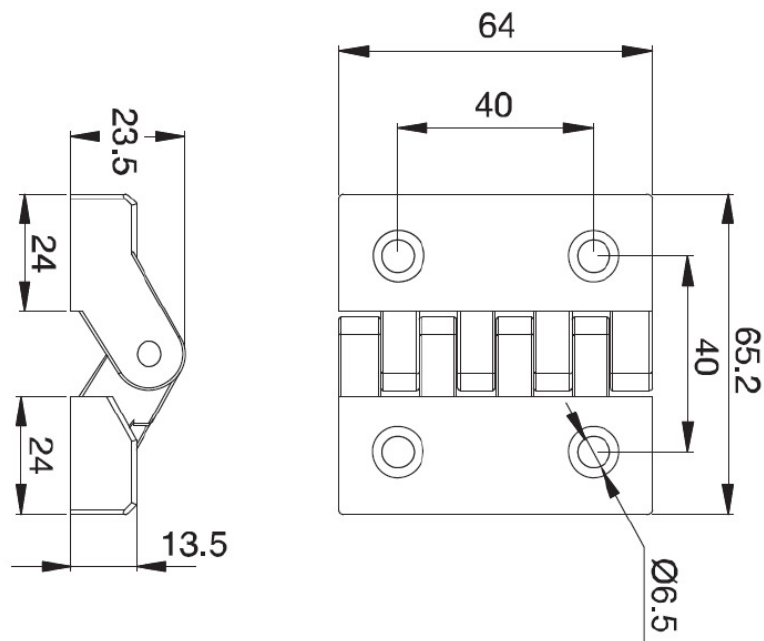
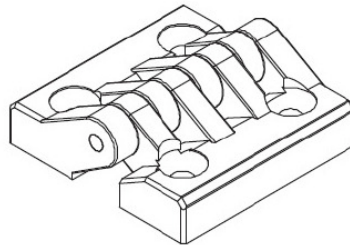

Overview of items

version	Part No.
Hinge with countersunk holes for M6	PA6120441-0PA